

Prívodky povrchové a nástěnné úhel 90° SpeedPRO | SpeedPRO wall mounted plugs 90°

SpeedPRO IP54

Prívodky povrchové úhel 90° / Wall-mounted plug 90°

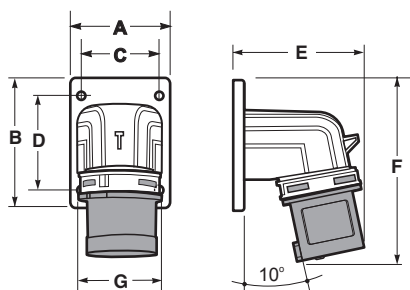

Počet pólů	16A			32A		
	3	4	5	3	4	5
A	66	66	66	90	90	90
B	86	86	86	100	100	100
C	52	52	52	77	77	77
D	61	61	61	85	85	85
E	90	90	90	110	110	110
F	120	120	120	160	160	160
G	56	60	73	73	73	79
Typ svorky	Šroubové svorky / Screw terminals					
Laněný vodič (mm²)	1-2,5			2,5-6		
Hmotnost (g)	127	147	167	230	250	273

- Se šroubovými přípojovacími svorkami
- Materiál pouzdra: PA6/ABS
- Materiál kontaktů: mosaz
- Chráněno proti stříkající vodě ze všech stran (IP54)

- With screw terminals
- Housing material: PA6/ABS
- Contacts: Brass

IP54 Splashproof

SpeedPRO IP67

Prívodky povrchové úhel 90° / Wall-mounted plug 90°

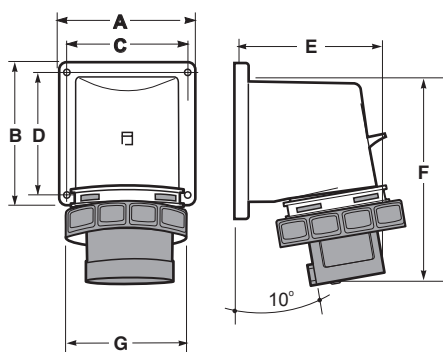

Počet pólů	16A			32A		
	3	4	5	3	4	5
A	66	66	66	90	90	90
B	86	86	86	100	100	100
C	52	52	52	77	77	77
D	61	61	61	85	85	85
E	90	90	90	110	110	110
F	120	120	120	160	160	160
G	70	77	87	93	93	99
Typ svorky	Šroubové svorky / Screw terminals					
Laněný vodič (mm²)	1-2,5			2,5-6		
Hmotnost (g)	167	187	207	265	285	307

- Se šroubovými přípojovacími svorkami
- Materiál pouzdra: PA6/ABS
- Materiál kontaktů: mosaz
- Chráněno proti dočasnému ponoření do vody (IP67)

- With screw terminals
- Housing material: PA6/ABS
- Contacts: Brass

IP67 Watertight

SpeedPRO IP54

Prívodky nástěnné / Wall plug

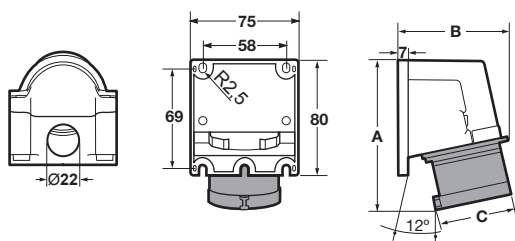

Počet pólů	16A		
	3	4	5
A	108	109	117
B	110	112	116
C	60	68	76
Typ svorky	Šroubové svorky / Screw terminals		
Laněný vodič (mm²)	1-2,5		
Hmotnost (g)	126	135	135

- Se šroubovými přípojovacími svorkami
- Materiál pouzdra: PA6/ABS
- Materiál kontaktů: poniklovaná mosaz
- Chráněno proti stříkající vodě ze všech stran (IP54)

- With screw terminals
- Housing material: PA6/ABS
- Contacts: Nickel-plated contacts

IP54 Splashproof

SpeedPRO IP54

Prívodky nástěnné / Wall plug

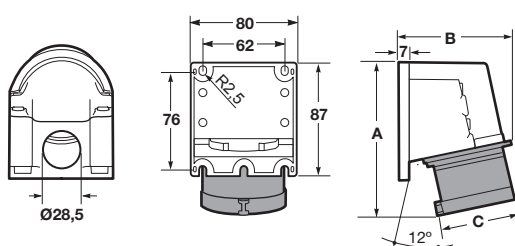

Počet pólů	32A		
	3	4	5
A	127	127	130
B	118	118	121
C	81	81	89
Typ svorky	Šroubové svorky / Screw terminals		
Laněný vodič (mm²)	1-2,5		
Hmotnost (g)	202	221	241

- Se šroubovými přípojovacími svorkami
- Materiál pouzdra: PA6/ABS
- Materiál kontaktů: poniklovaná mosaz
- Chráněno proti stříkající vodě ze všech stran (IP54)

- With screw terminals
- Housing material: PA6/ABS
- Contacts: Nickel-plated contacts

IP54 Splashproof

# 1.3 PŘÍVODKY A ZÁSUVKY PRO NÁSTĚNNOU MONTÁŽ IP54/IP67; 16A - 125A

## 1.3 WALL MOUNTED SOCKETS AND PLUGS IP54/IP67 16A - 125A



3P=2P+PE  
4P=3P+PE  
5P=3P+PE+N

<b>110V</b> 50/60Hz	<b>230V</b> 50/60Hz	<b>400V</b> 50/60Hz	<b>500V</b> 50/60Hz
------------------------	------------------------	------------------------	------------------------

Amp.	Počet pólů	Balení	Póly: 3P 4P 5P H.úhel: 4h 4h 4h	Póly: 3P 4P 5P H.úhel: 6h 9h 9h	Póly: 3P 4P 5P H.úhel: 9h 6h 6h	Póly: 3P 4P 5P H.úhel: 7h 7h 7h
------	------------	--------	------------------------------------	------------------------------------	------------------------------------	------------------------------------

<b>16</b>	3	4	<b>13150</b>	<b>13250</b>	<b>13354</b>	<b>13454</b>
	4	4	<b>13151</b>	<b>13251</b>	<b>13350</b>	<b>13450</b>
	5	4	<b>13154</b>	<b>13252</b>	<b>13351</b>	<b>13451</b>
<b>32</b>	3	2	<b>13152</b>	<b>13253</b>	<b>13355</b>	<b>13455</b>
	4	2	<b>13153</b>	<b>13254</b>	<b>13352</b>	<b>13452</b>
	5	2	<b>13155</b>	<b>13255</b>	<b>13353</b>	<b>13453</b>

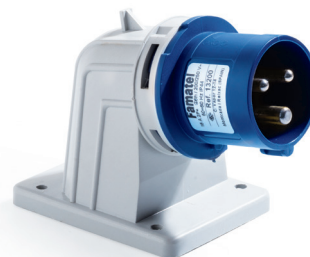

Obj. č. / Item **13250** **CE**



<b>16</b>	3	4	<b>14150</b>	<b>14250</b>	<b>14363</b>	<b>14456</b>
	4	4	<b>14151</b>	<b>14251</b>	<b>14350</b>	<b>14450</b>
	5	4	<b>14159</b>	<b>14252</b>	<b>14351</b>	<b>14451</b>
<b>32</b>	3	2	<b>14152</b>	<b>14253</b>	<b>14364</b>	<b>14457</b>
	4	2	<b>14153</b>	<b>14254</b>	<b>14352</b>	<b>14452</b>
	5	2	<b>14160</b>	<b>14259</b>	<b>14353</b>	<b>14453</b>

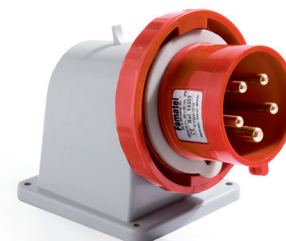

Obj. č. / Item **14353** **CE**



<b>16</b>	3	10	<b>13196</b>	<b>13297</b>	<b>13398</b>	<b>13481</b>
	4	10	<b>13197</b>	<b>13298</b>	<b>13399</b>	<b>13482</b>
	5	10	<b>13198</b>	<b>13299</b>	<b>13395</b>	<b>13483</b>

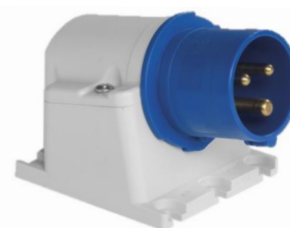

Obj. č. / Item **13297** **CE**



<b>32</b>	3	6	<b>13199</b>	<b>13306</b>	<b>13407</b>	<b>13484</b>
	4	6	<b>13208</b>	<b>13307</b>	<b>13396</b>	<b>13485</b>
	5	6	<b>13207</b>	<b>13308</b>	<b>13397</b>	<b>13486</b>



Obj. č. / Item **13397** **CE**

